



Wi-Tek Product Line Introduction

Innovate & Explore with Wi-Tek.
Design for SMB Network



Come and Explore more cloud solutions with Wi-Tek.

Overall Wi-Tek Product

Cloud Outdoor
Easy Smart Switch



Cloud Switch



L3

L2+

Easy
Smart

Full
Gigabit

250-
meter

Cloud
Wireless Transmitter

1 km 3 km 5 km



Cloud
4G Router



Wireless Mesh
Router & AP



Industrial Switch

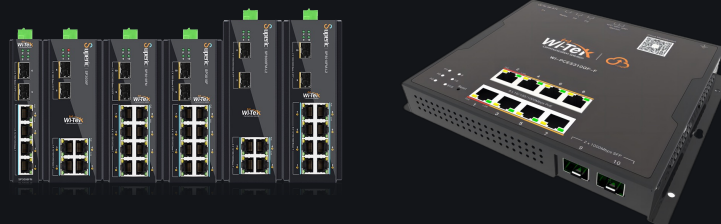

Cloud AP +
Secure Gateway

Wi-Fi 4

Wi-Fi 5

Wi-Fi 6



Cloud Solar
Powered PoE Switch



Cloud POL



Accessory



IoT Box



Cloud
Service

Available on the
App Store

Google play

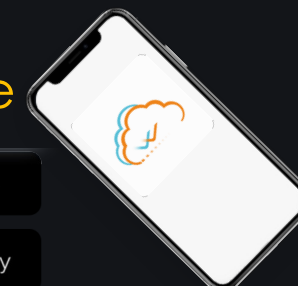

Wi-Tek Cloud Service



Network Topology



Device Status Overview



Remote Device Configuration



Real-time Network Analysis



Wireless Optimization



Alarm Notification



Project Share



- Free Service
- Business Booster
- Technical Booster

Unlimited network group support

Name	Configure	Alarm	AP	Gateway	Switch	Configuration
OFFICE_415	SHARE EDIT	1743	0/1	1/1	1/1	WIRELESS NETWORK
HOME_AIDEN	SHARE EDIT	8	0/0	1/1	0/0	WIRELESS NETWORK
OFFICE_402	SHARE EDIT	10	0/0	0/0	0/0	WIRELESS NETWORK
WI-LTE117-O_IPC1	SHARE EDIT	39	0/0	0/0	0/0	WIRELESS NETWORK
JENNIFER_HOME	SHARE EDIT	0	0/0	0/0	0/0	WIRELESS NETWORK

Records per page: 5 1-5 of 11

Data statistics

- 11 Network
- 21 Online User
- 12 / 14 Online/Total Device
- 6 / 8 Receive/Send request

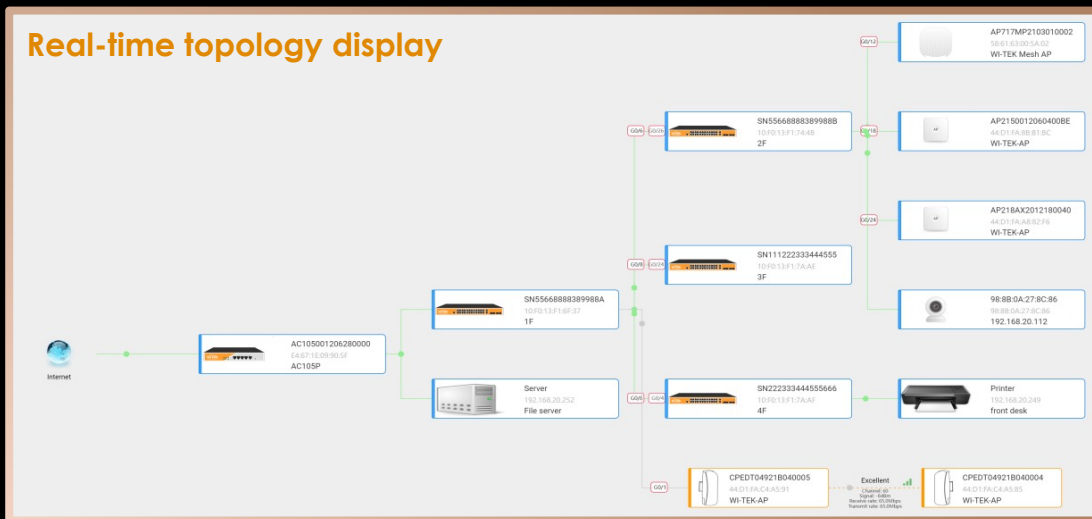

Flexible network permissions

GROUP SHARE

ADD GROUP ADD NETWORK BACK

aiden.chen@wireless-tek.com EDIT HANDOVER

- Group1 EDIT HANDOVER DELETE
- OFFICE_415 EDIT HANDOVER SHARE DELETE
- Home_Aiden EDIT HANDOVER SHARE DELETE
- OFFICE_402 EDIT HANDOVER SHARE DELETE

Add EWEB **Remotely access the Web interface** BACK

Create EWEB tunnel success, please click the following link to access or copy the link and open it in web browser.

<http://10859e65.eweb.wireless-tek.com>

Cloud Switch-Cloud L3 Managed Switch

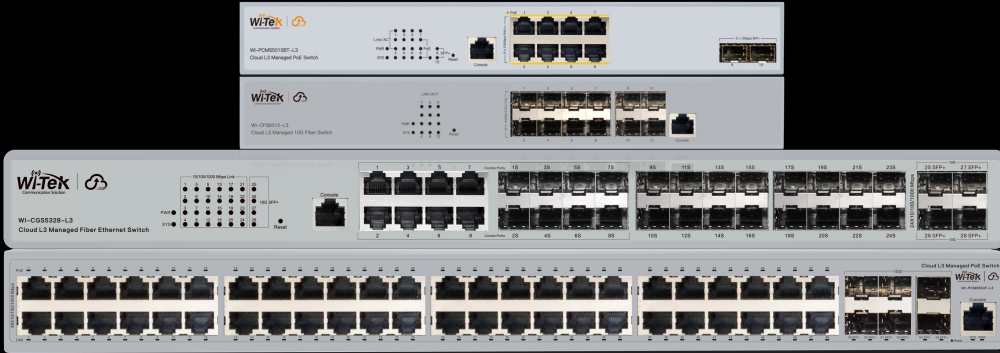
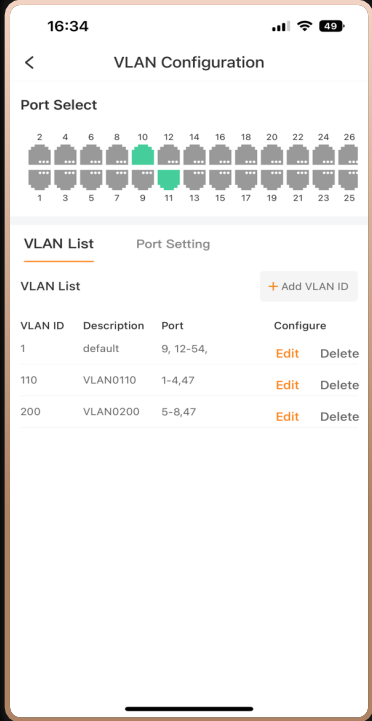
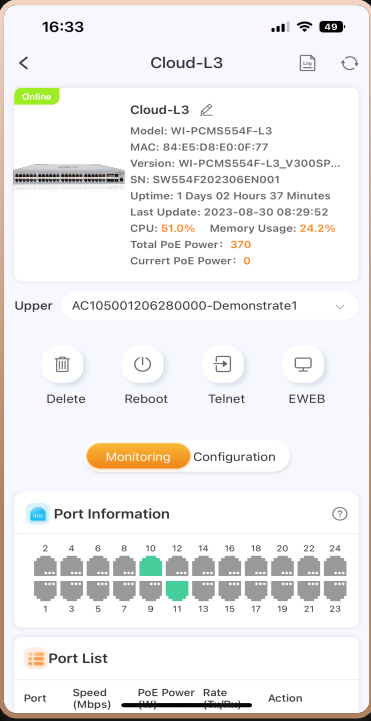
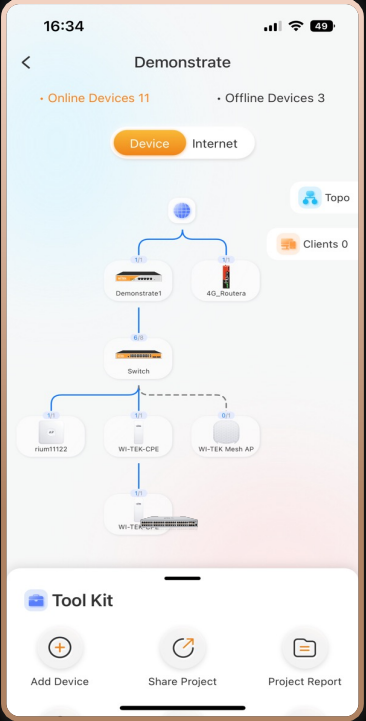

Cloud Management

Layer 3 Routing Protocol



New Hardware Optimize

PoE Output

10G High-speed Uplink

300+ Terminal Devices

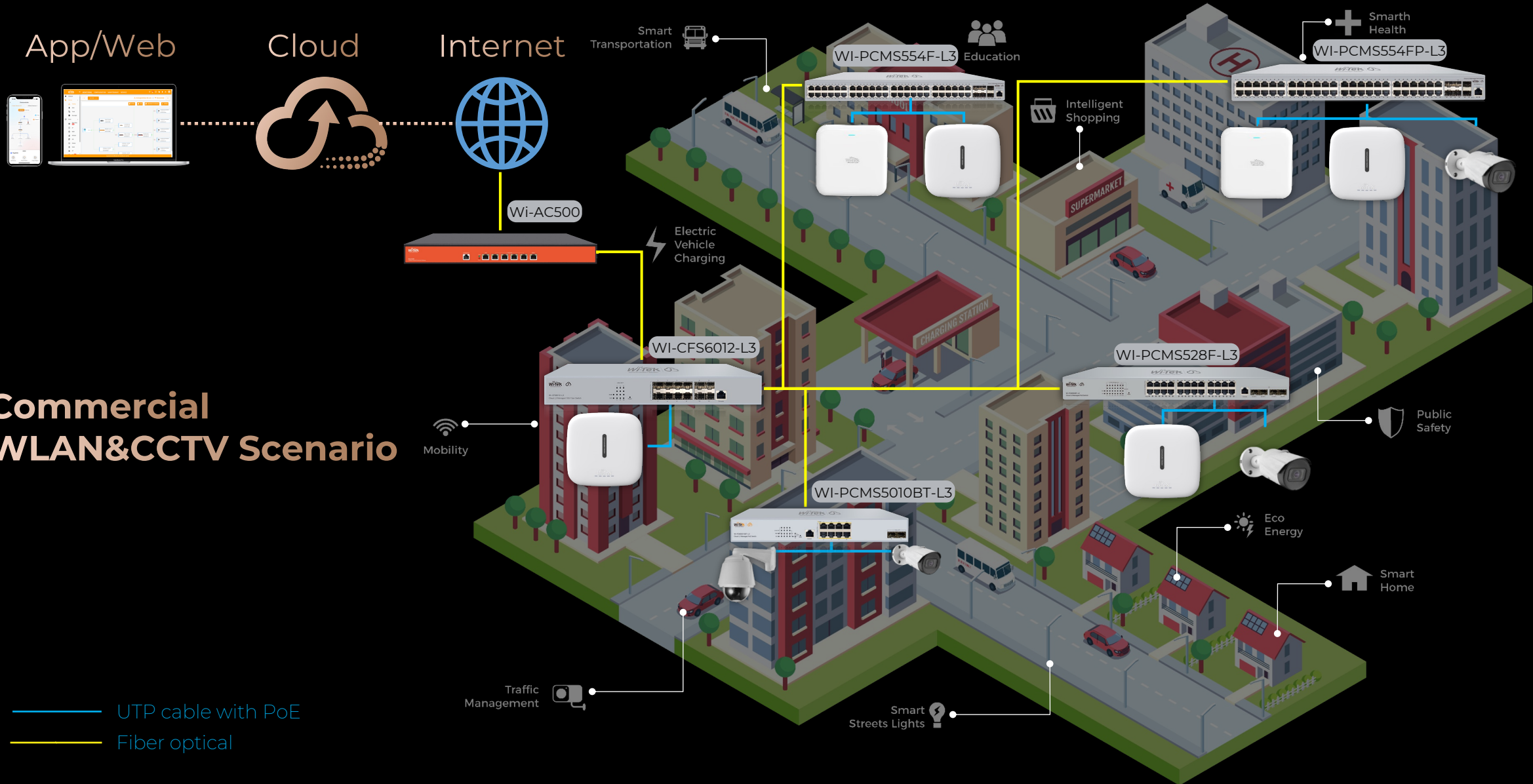
Cloud Switch-Cloud L3 Managed Switch



Commercial WLAN&CCTV Scenario

Cloud Switch-Cloud L2+ Managed Switch

140W PoE



370W PoE



Fiber



Non-PoE



Coming Soon

Non-PoE



Non-PoE



Cloud Management



Layer 2+ Upgrade



ERPS



DHCP Service



Static Routing



50-200 Terminal Devices

Cloud Switch-Cloud L2+ Managed Switch

General Hospital WLAN&CCTV Scenario



Cloud



Internet



WI-AC150

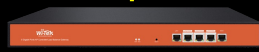

- UTP cable
- UTP cable with PoE
- Fiber optical

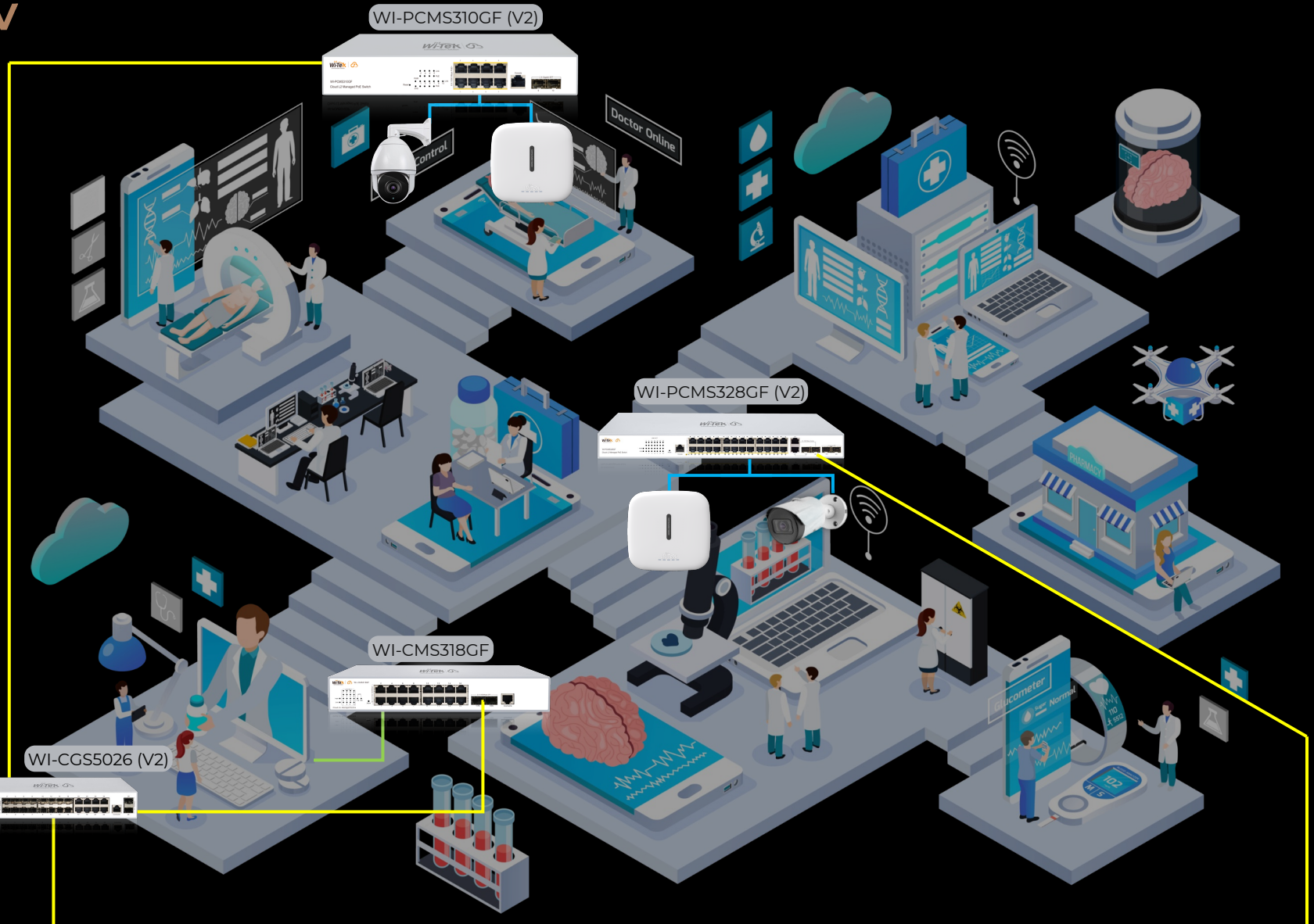

Cloud Switch-Cloud Easy Smart Switch

Office WLAN&CCTV Scenario

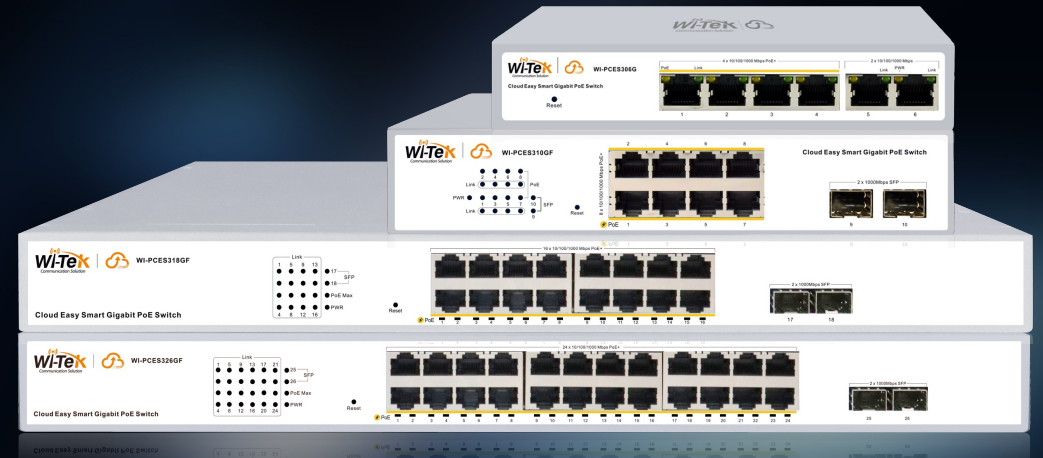
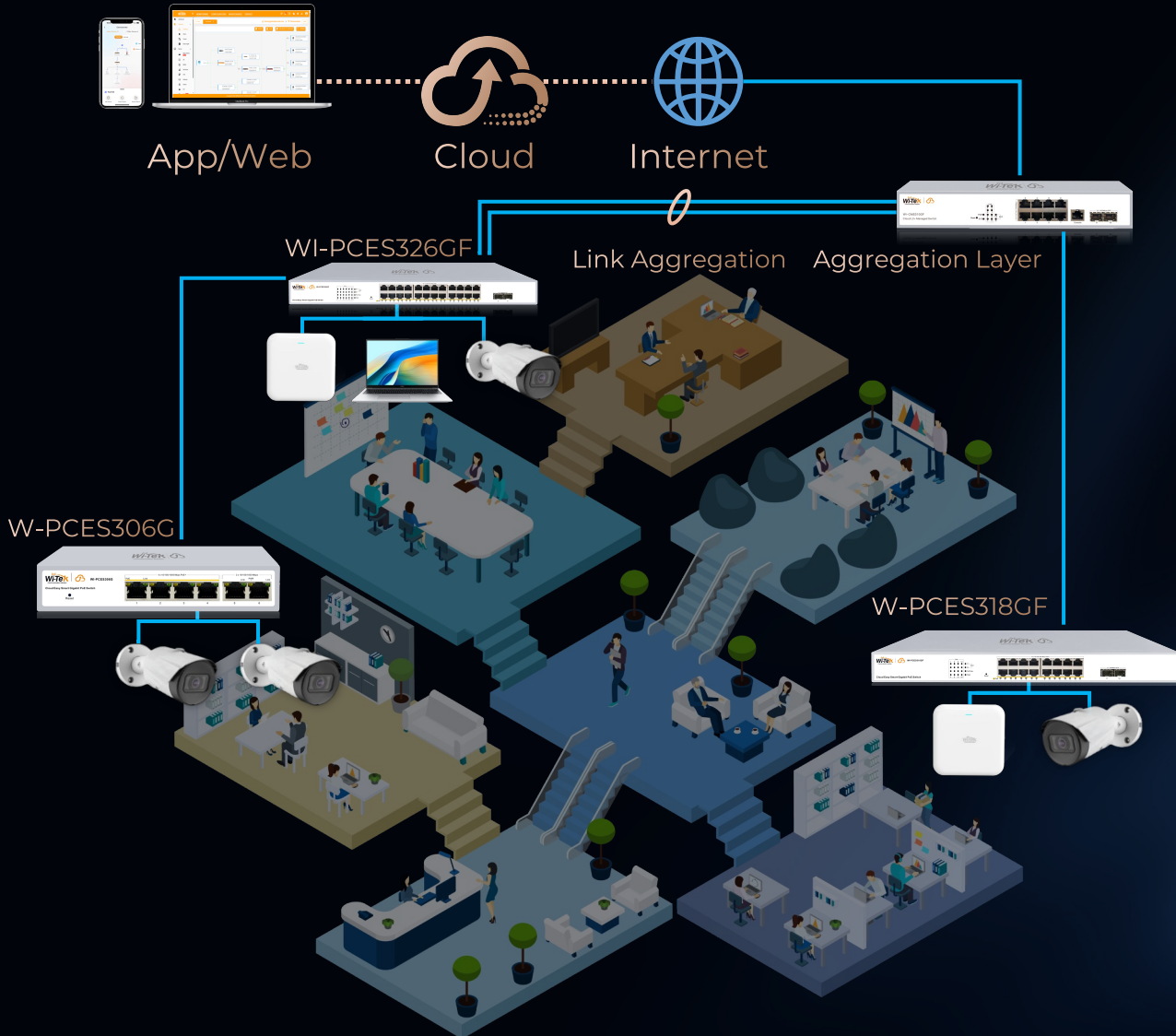

Cloud Management

New Hardware Optimize

Remote Configuration

Alarm Notification

ONVIF Detect

Less 50 Terminal Devices

250-meter Long-Range PoE Switch



Warehouse CCTV Scenario

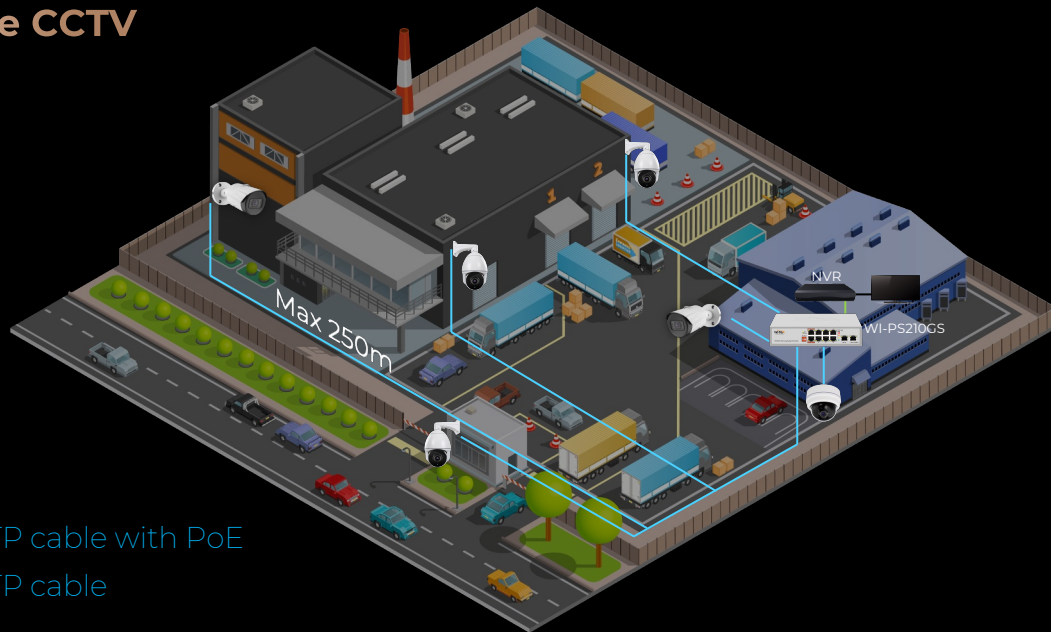

— UTP cable with PoE
— UTP cable



Port Isolation



Reasonable Power Budget



Watchdog

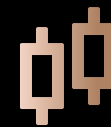

Double Uplink Ports



Extend to 250m



Smart DIP Mode

Multi Gigabit Ethernet Switch

2.5Gbps PoE Switch

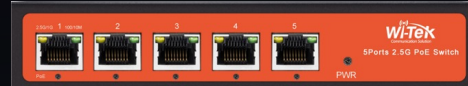

2.5Gbps Ethernet Switch

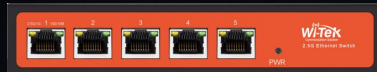

2.5Gbps PoE Injector



2.5G Gaming PC



2.5G NAS



Laptop with 2.5G Ethernet Adapter



Wi-Fi 6 AP



4k Video

2.5G

Full Gigabit Port Design



802.3af/at PoE output



Plug and play



Fan less Noiseless Design

Cloud Outdoor PoE Switch

Cloud Outdoor Easy Smart Switch

IP65
Waterproof

-30-70 °C
Operating Temperature

6KV
Surge Protection

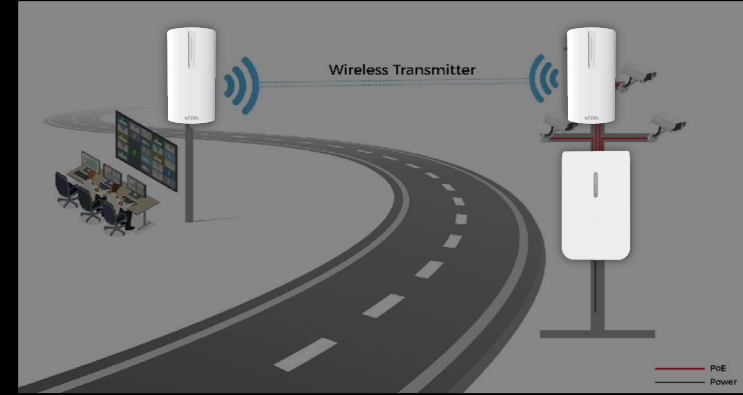

- No need to buy an extra metal box.
- wall mount and pole mount
- Managed switch
- All In One



Cloud
Management



Hi-PoE



Extend to
250m



ONVIF



Watchdog



Automatic Loop
Prevention

Wireless Long-range Transmitter for CCTV

-30-70°C

Operating Temperature

6KV

Surge Protection

1-5KM

Transmission Distance

IP65

Waterproof

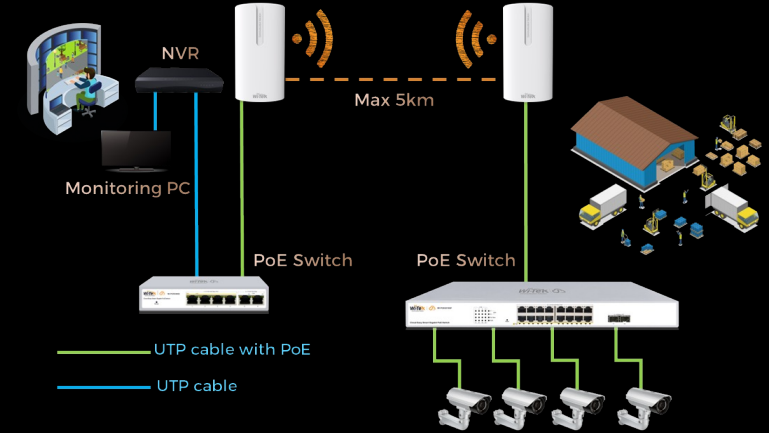

PTP/PTMP



One Key Fast Paired



Cloud Management



Pre-Configuration



Poe Input/Output

Wireless Long-range Transmitter for CCTV

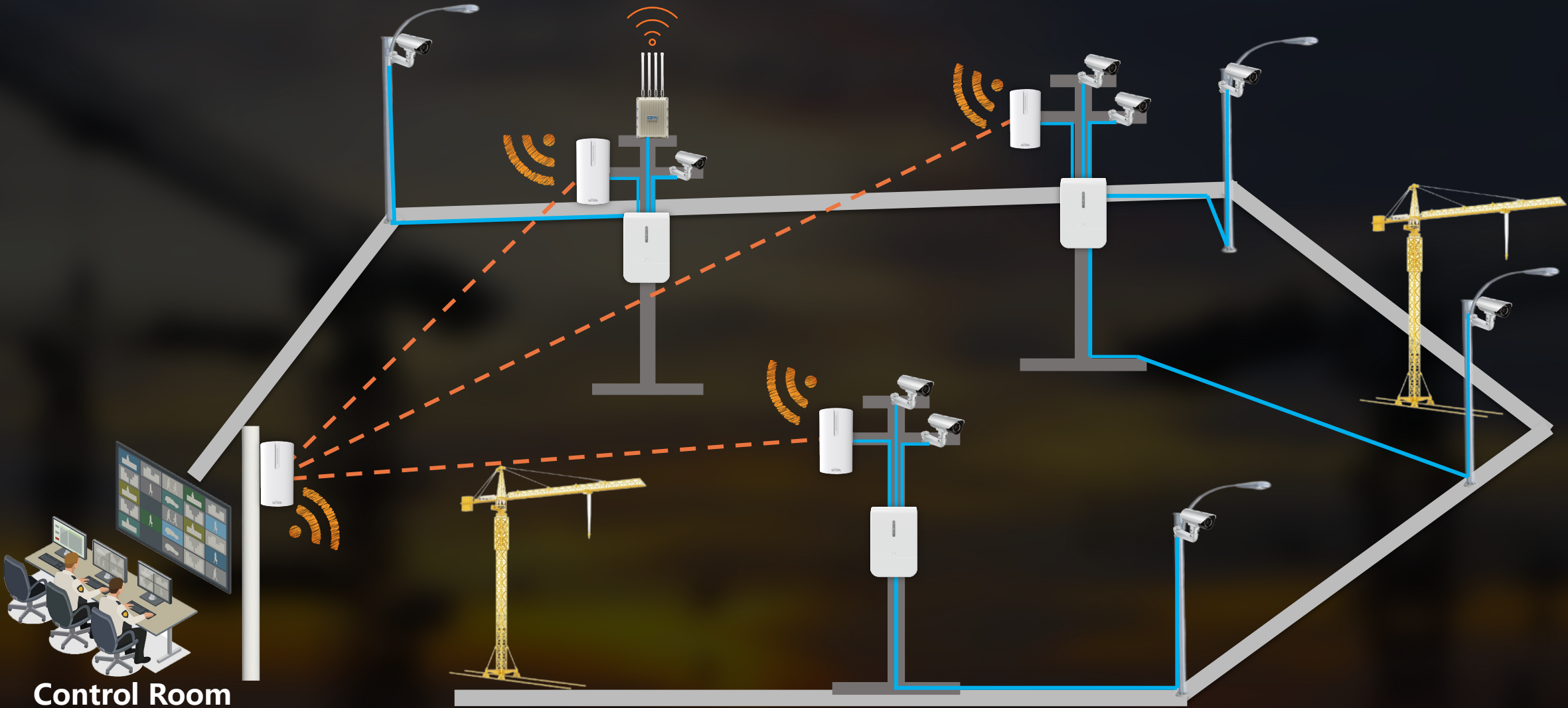

Control Room

— UTP cable with PoE

Solar Powered PoE Switch

High power supply priority

Low power supply priority

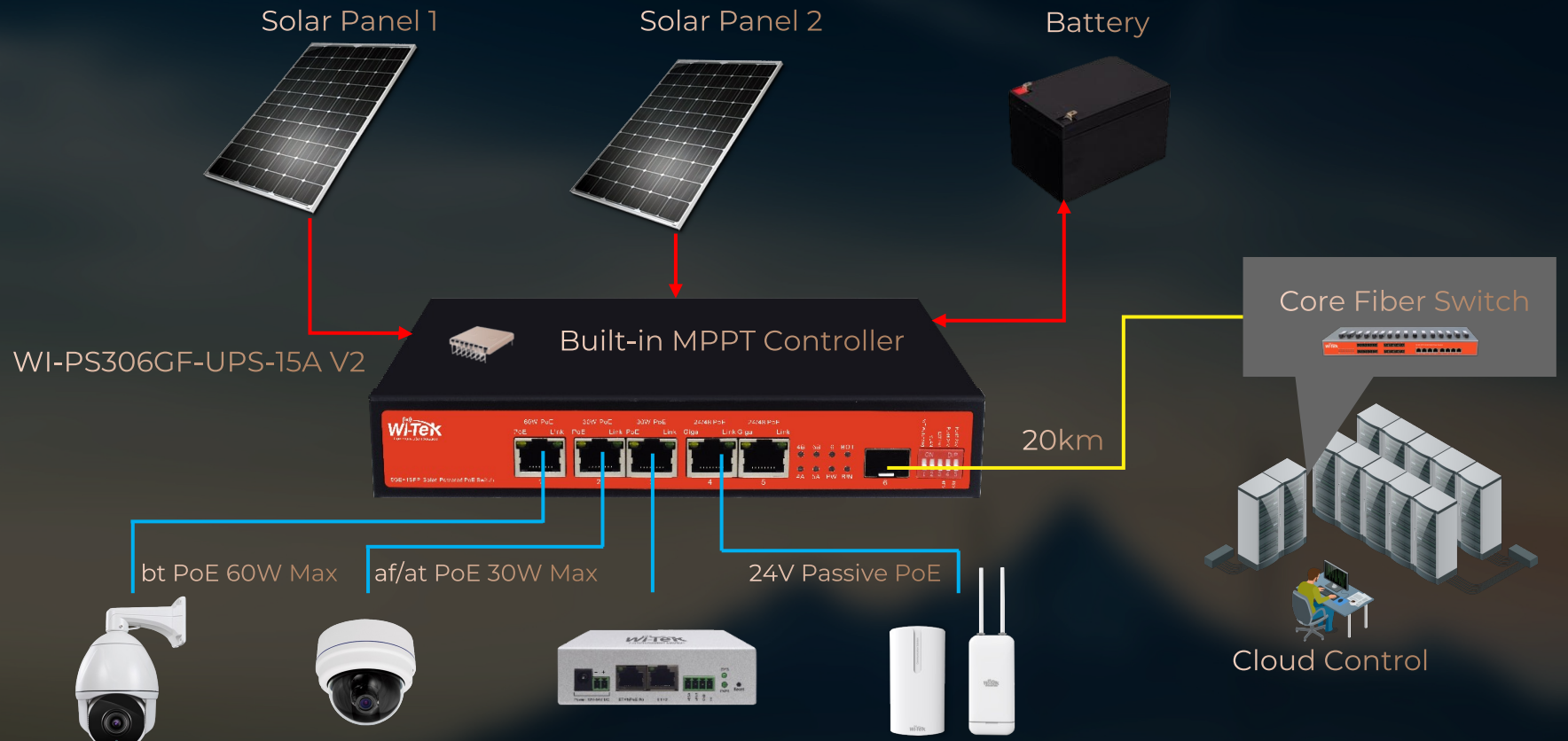

WI-PS306GF-UPS-15A V2

Built-in MPPT Controller

Core Fiber Switch

20km

bt PoE 60W Max

af/at PoE 30W Max

24V Passive PoE

PTZ Camera

IP camera

WI-IOT100

Wireless CPE/4G Router

Cloud Control

- Power cord
- UTP cable with PoE
- Fiber optical

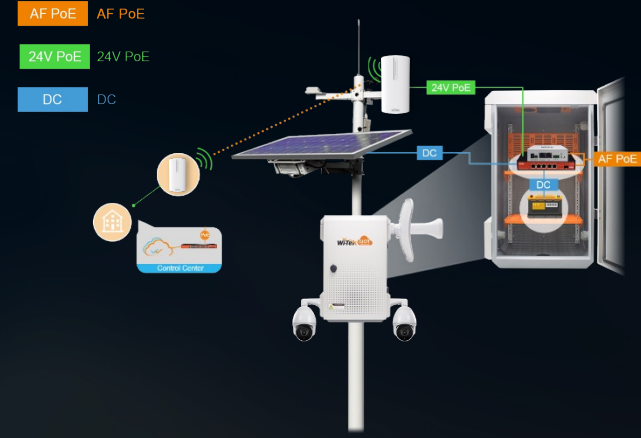

- Status Trendline
- Build-In MPPT
- Multiple Power Supply Modes
- Cloud Management
- Multiple PoE Type Output
- Battery Charging & Discharging

Industrial Switch-Superic Industrial Switch

Control Centre

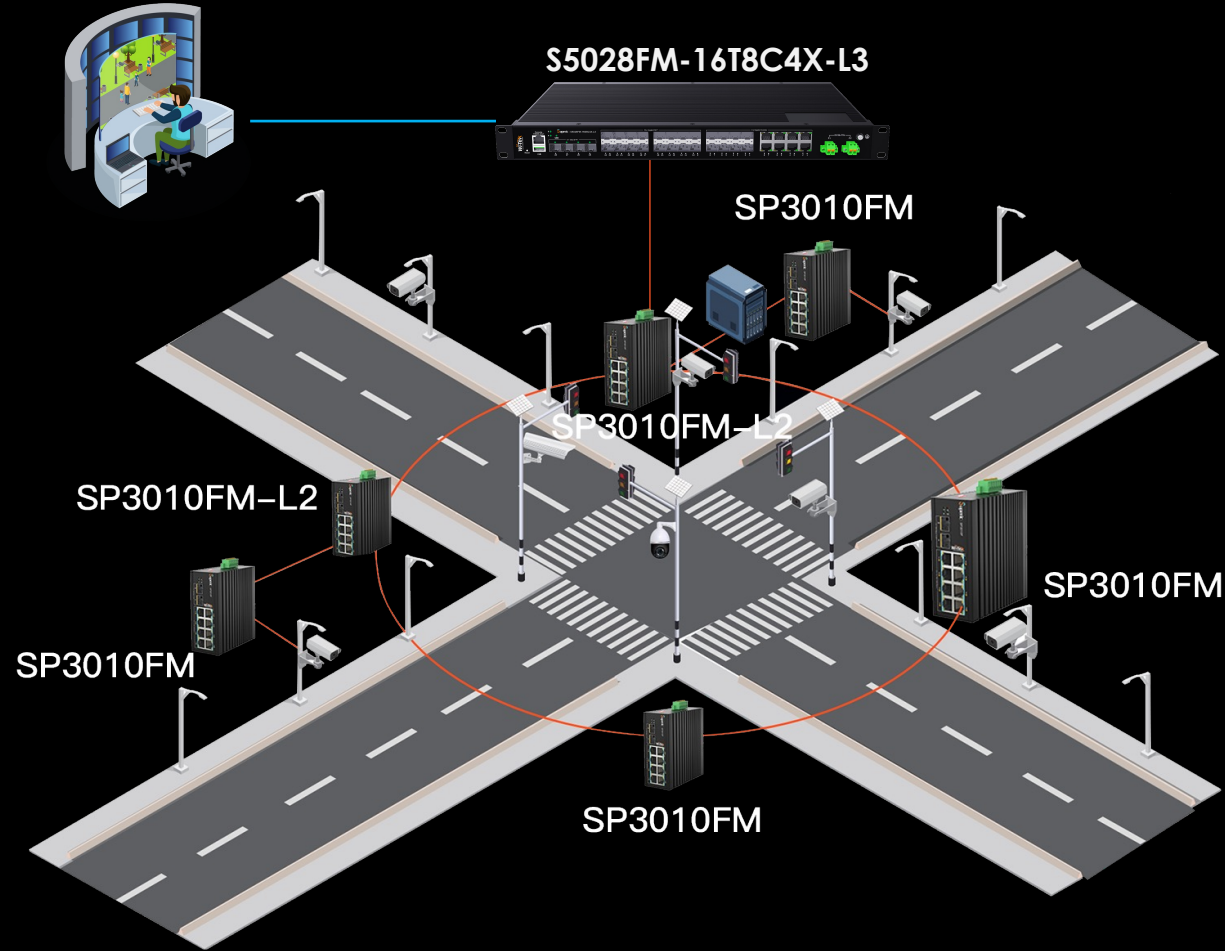

L3/ L2/ Easy Smart/ Unmanaged Model

<p>6 kV Surge Immunity 15 kV ESD Protection</p>	<p>802.3bt 90W PoE Upgrade</p>	<p>Redundant Power Input Interface</p>	<p>Professional Safe Circuit & Shell</p>
<p>-40~75°C Operating Temperature</p>	<p>10G SFP+ Uplink</p>	<p>Polarity Reverse Protection Over-voltage/ Current Protection</p>	

Industrial Switch-Cloud L2 Management Industrial Switch

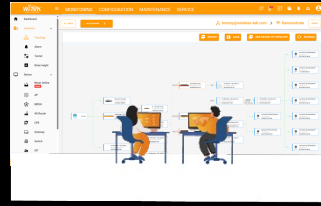

Control Room

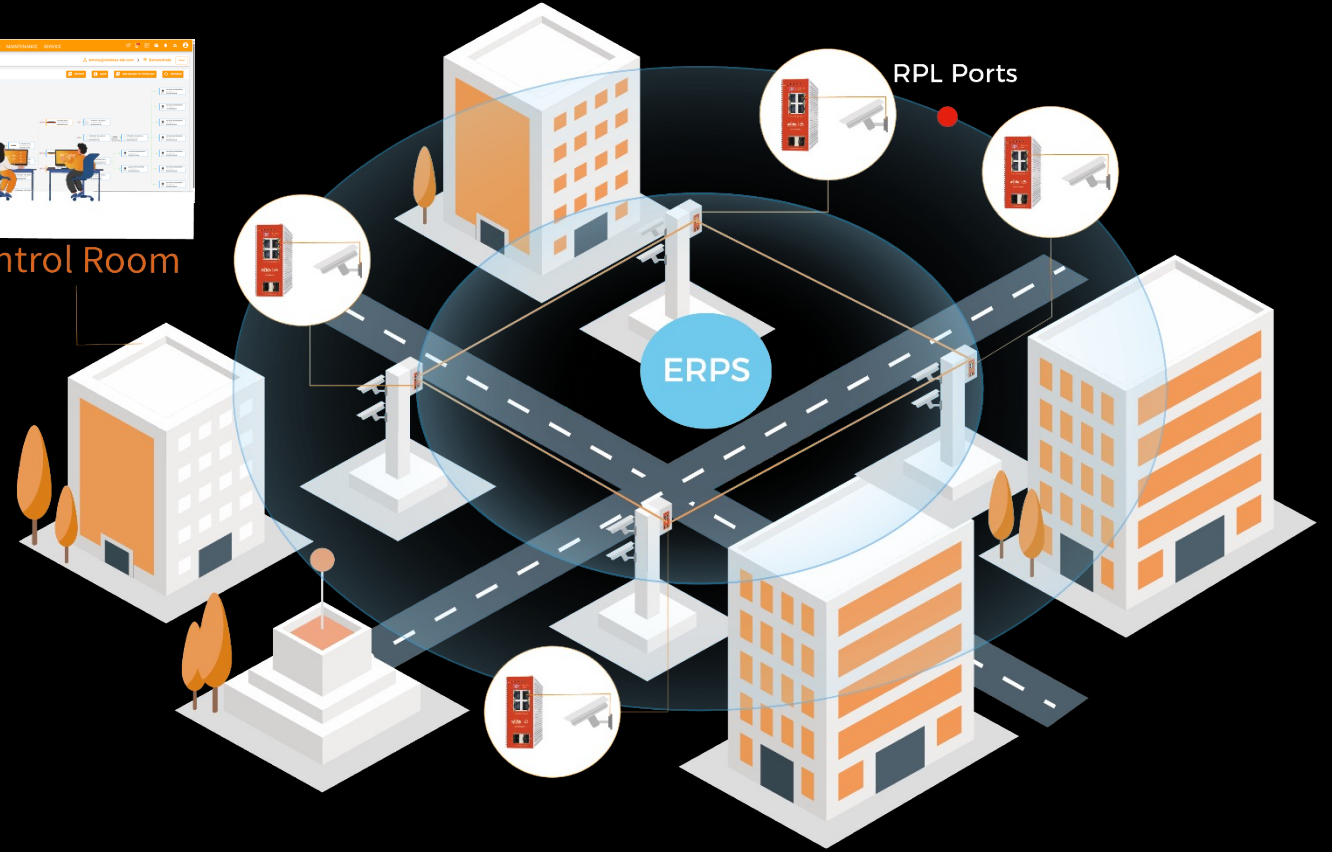

Cloud Management



Layer 2 Management



ERPS



802.3 af/at/bt
90W PoE



48-57V
Redundant
Power



-40-75°C
Working
Temperature

Industrial Switch-Cloud Industrial Flat Switch



Flat Type

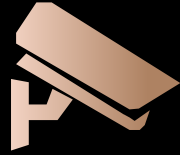

ONVIF



Cloud Management

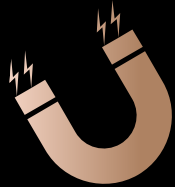

Magnetic Mounting



Temperature/Humidity Sensor



802.3af/at/bt
90W PoE



Industrial Switch-Boost Voltage Industrial Switch

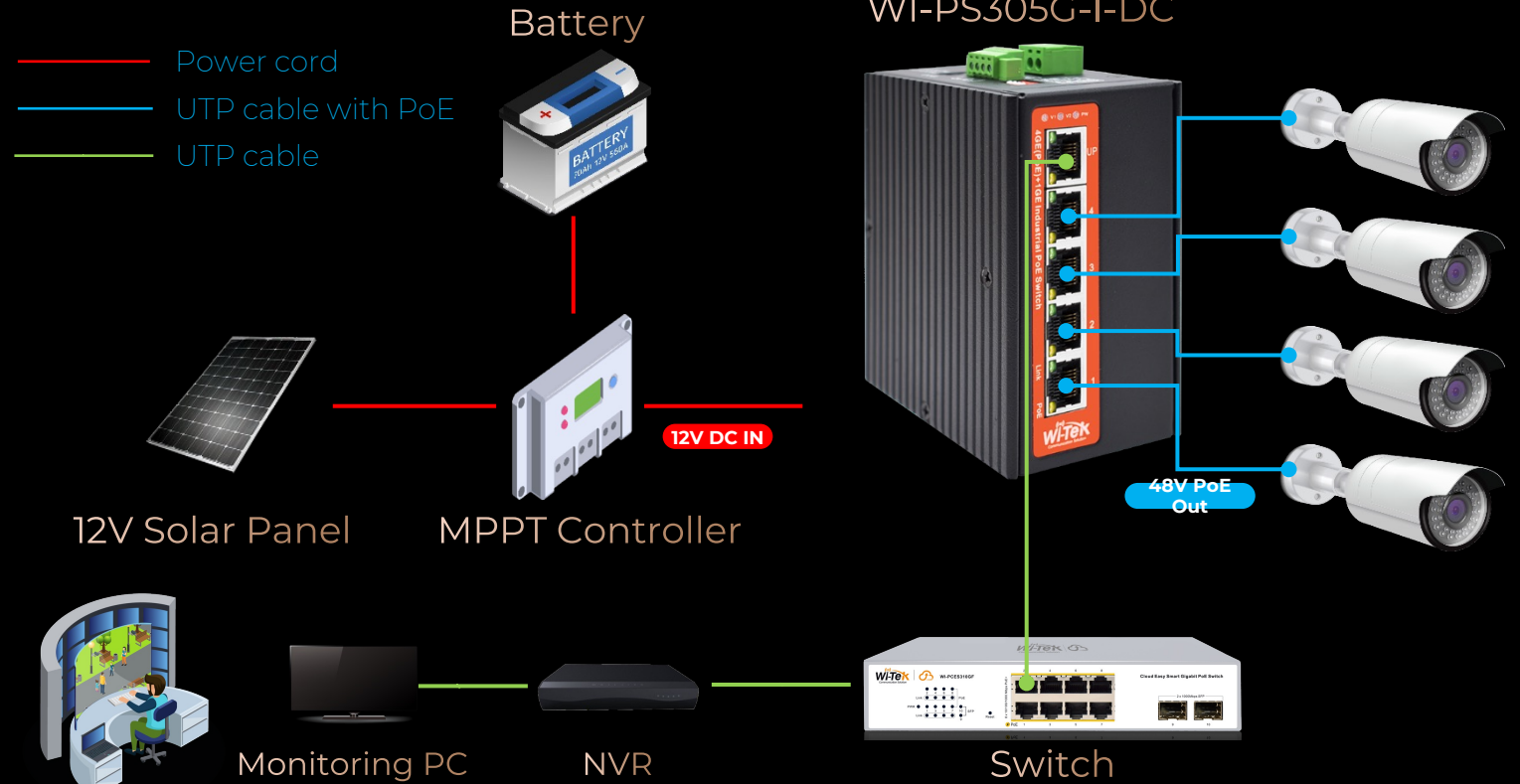

9~52V
Power Input

802.3 af/at/bt
90W PoE

Smart
DIP Mode

Industrial Switch-Hardened PoE Switch

Support 802.3af/at/bt 90W PoE Output

802.3bt 90W
PoE Output



PTZ Speed Dome



Digital Signage



Digital Signage



802.11ax AP

802.3bt 30W
PoE Output



IP Camera



VoIP Phone



Alarm System



Wireless AP

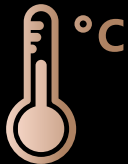

-30~65 °C
Working Temperature



802.3 af/at/bt
90W PoE

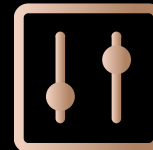

Smart DIP Mode

Cloud Secure Gateway

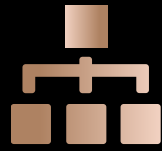

SD-LAN



Multiple VPN



Multiple WAN



Captive Portal



AC Mode



Cloud Management



AP Auto Discovery



Band Steering

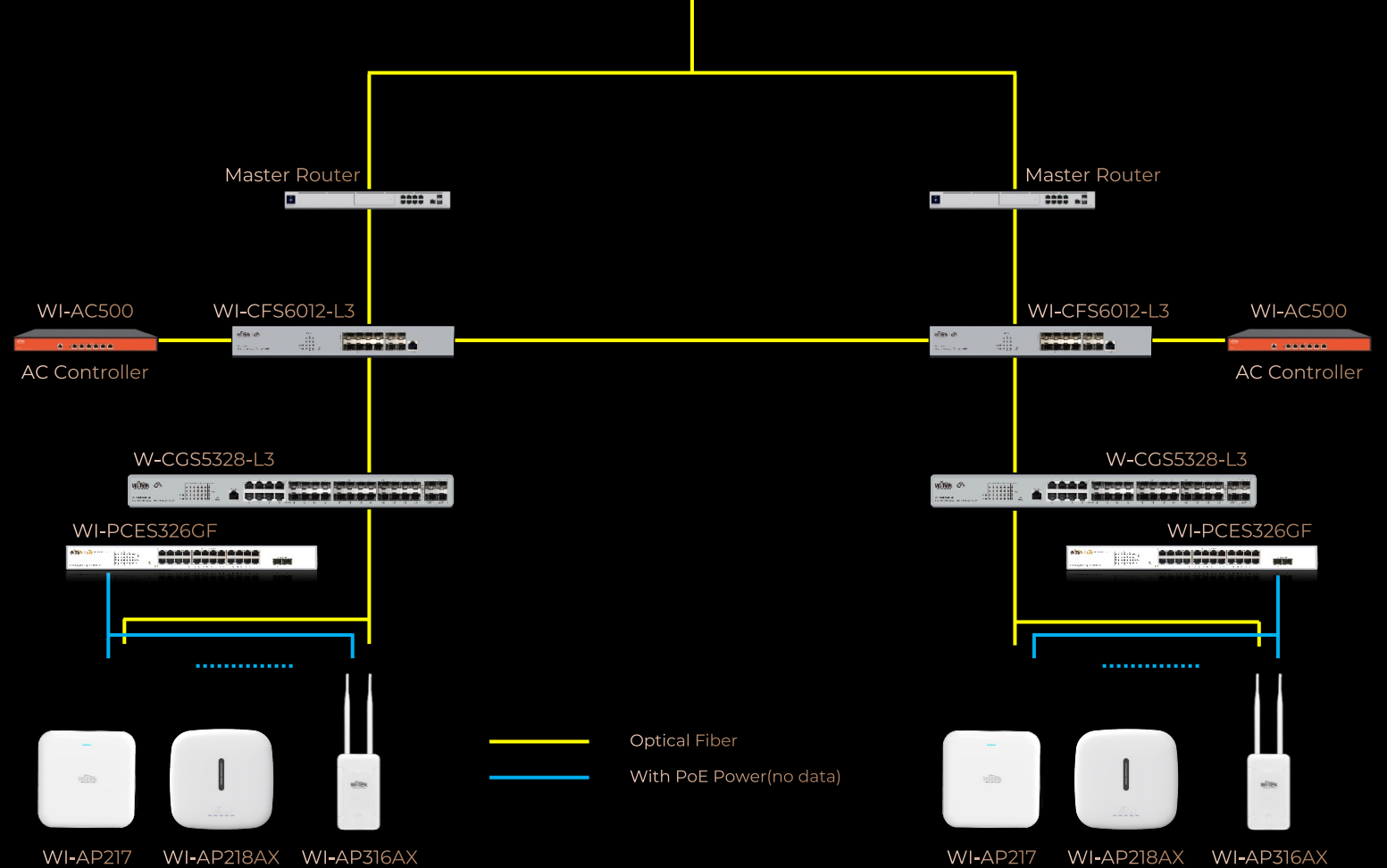

Cloud Wireless Access Point

Ceiling-mount



AP210-Lite
AP216



AP217
AP217(-Lite)



AP218AX(-Lite)
AP219AX(-Lite)

Outdoor



AP310(-Lite)
AP316



AP315
AP317



AP510



AP316AX



AP518AX

Wall-plate



AP416



AP417P

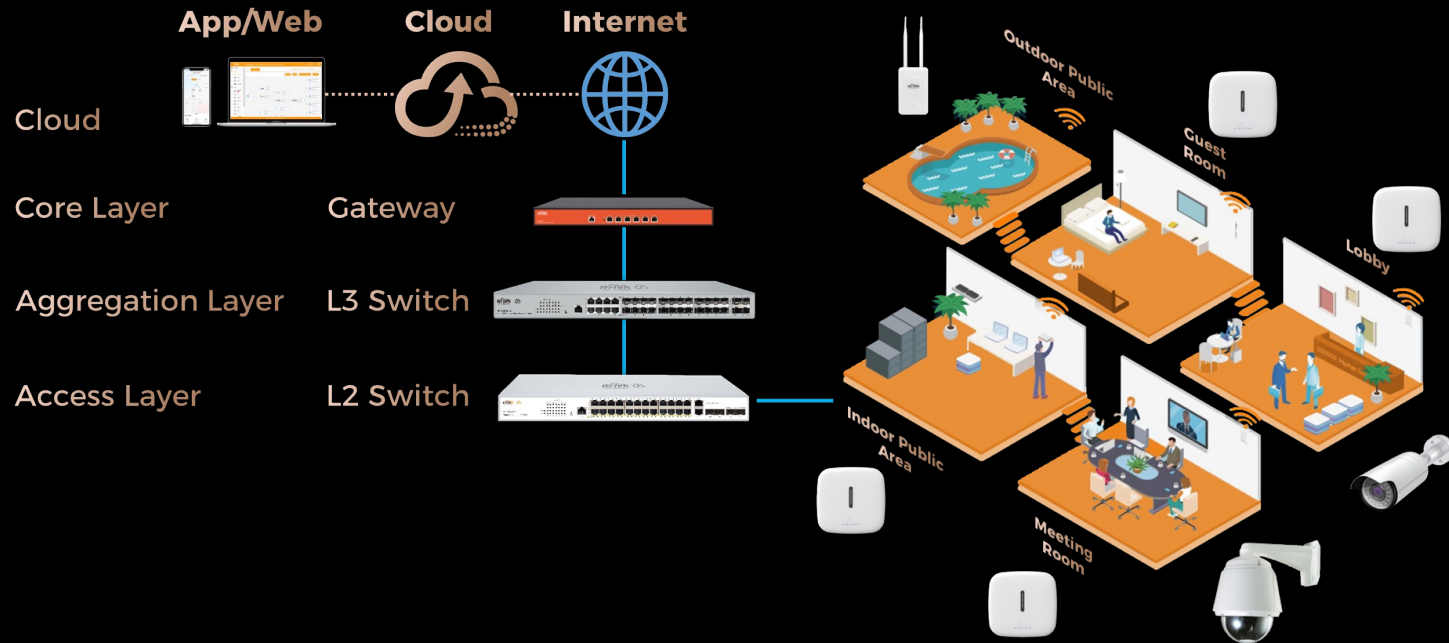

Multiple SSID

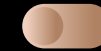

Fit/Fat Mode



Captive Portal



Redundant Input Power



Cloud Management



Fast Roaming

GLOBAL CASE



Built-in Fan



Anti-theft

3

Installation Methods



Firm Structure



Modular Installation



IP65 Ingress Protection



Lightning Protection

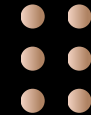

Dustproof



Anti Corrosion

Wireless Mesh Router & AP

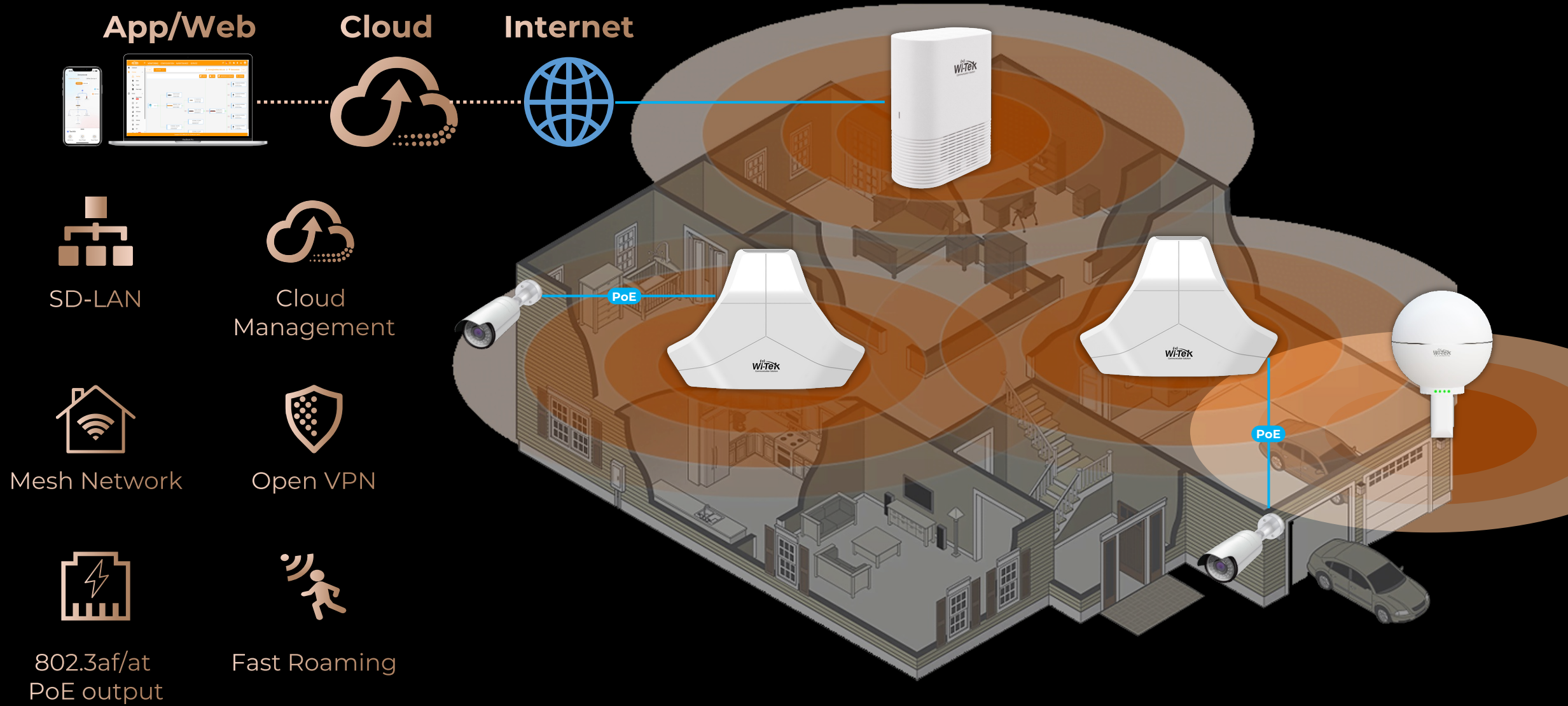

4G CPE/Router



Cloud Management

Open VPN

SD-LAN

IP65

4G/ETH Failover

CAT4/6

300Mbps

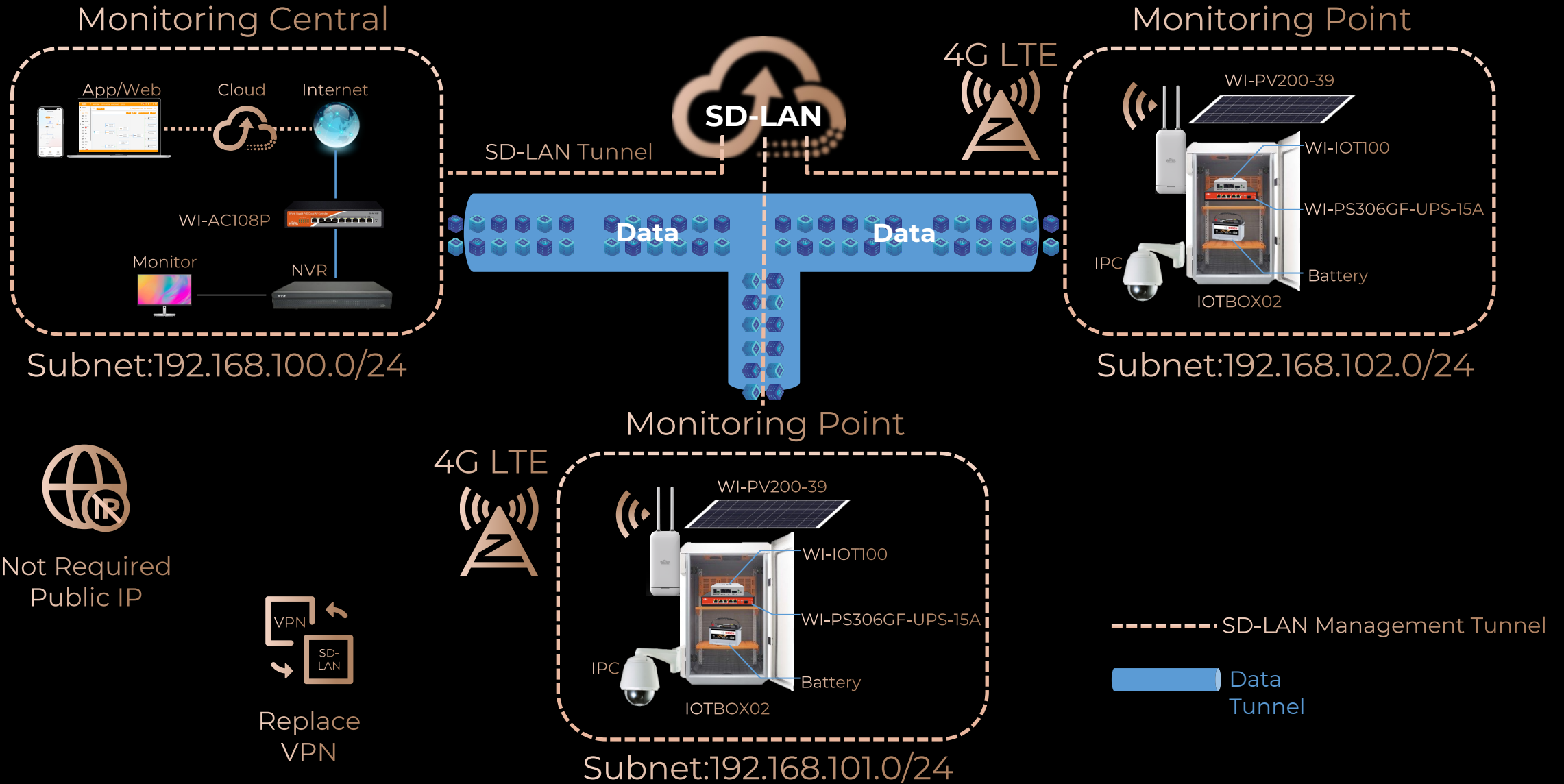

Not Required
Public IP

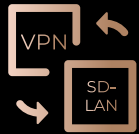

Replace
VPN

----- SD-LAN Management Tunnel

————— Data Tunnel



WI-POL5800-08

- GPON OLT
- 8*GPON SC Fiber and 4*10G SFP+ Fiber , 4*1G RJ45



WI-POL308G-P

- GPON MDU
- 8*GE RJ45 and 1*2.5G GPON SC Fiber
- 120W PoE Budget

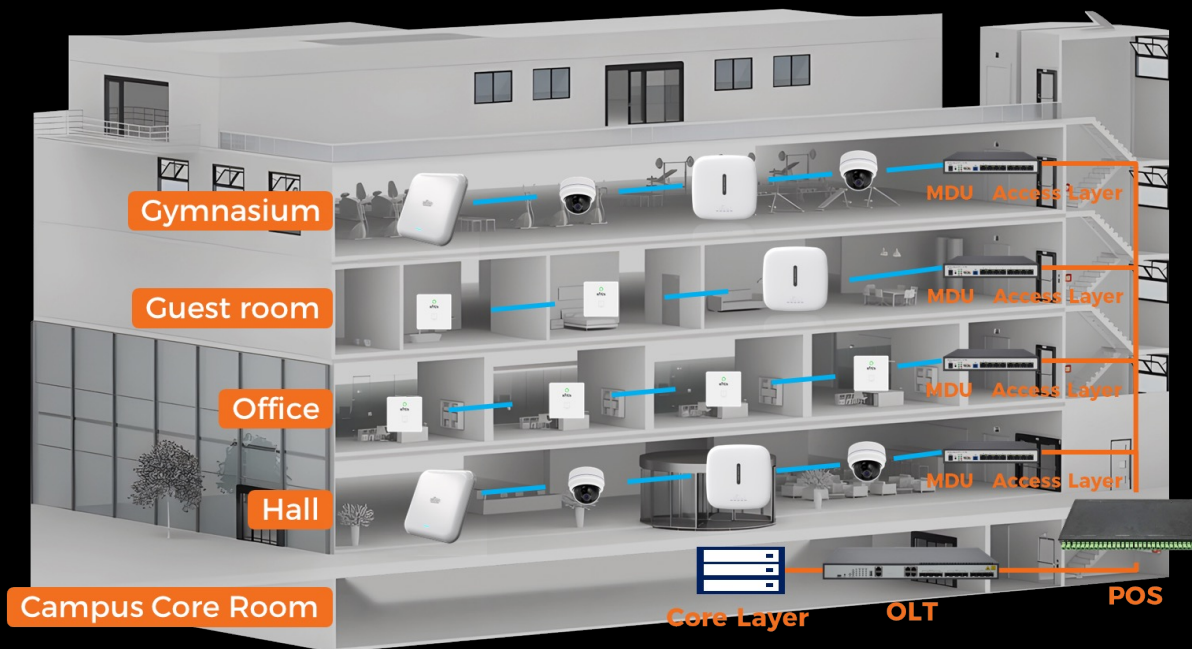

Next Generation
All-optical Network



Cloud Management
By App/Web



20km
Transmission Distance



Energy And
Cost Saving



TCO
Reductions



Simple
Maintenance

POL Product

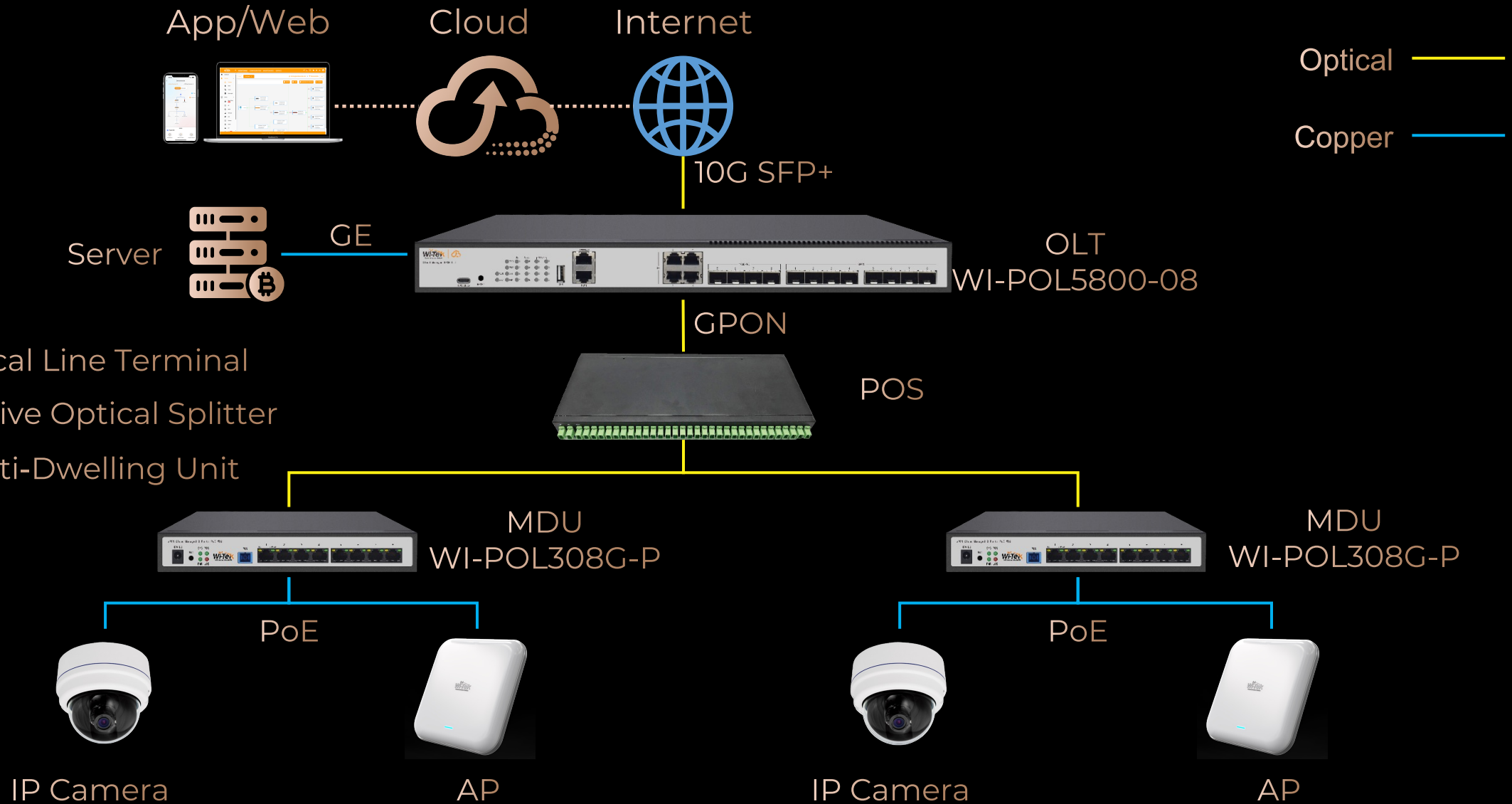

OLT: Optical Line Terminal
POS: Passive Optical Splitter
MDU: Multi-Dwelling Unit

Accessory-PoE Media Converter

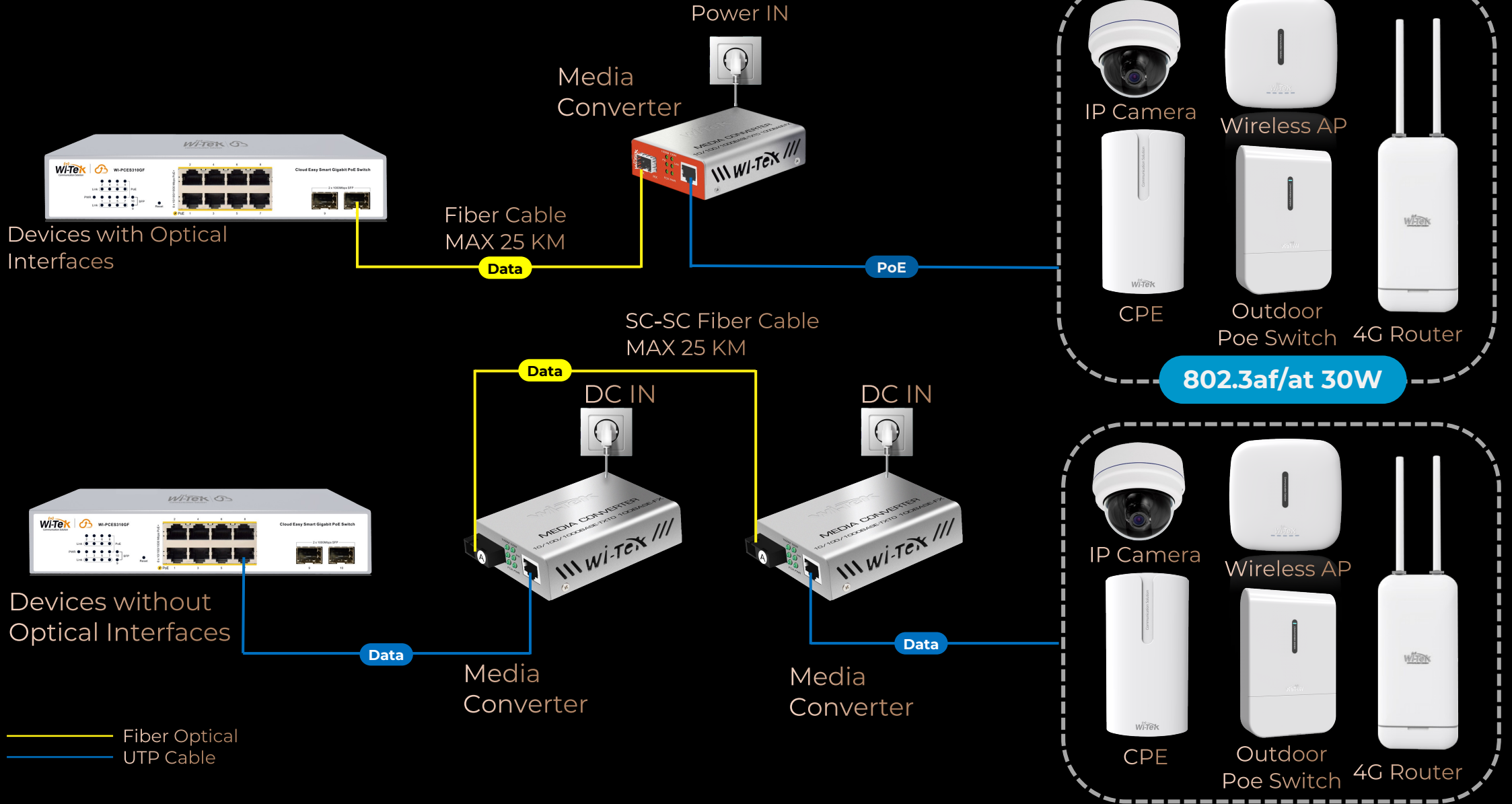

Accessory-PoE Injector

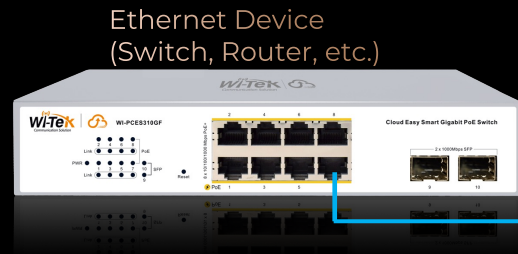
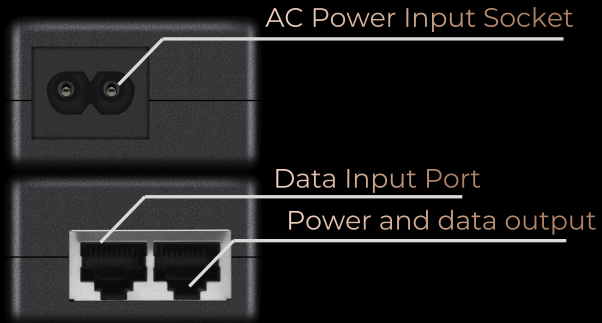

- UTP Cable with PoE
- UTP Cable

Accessory-PoE Splitter

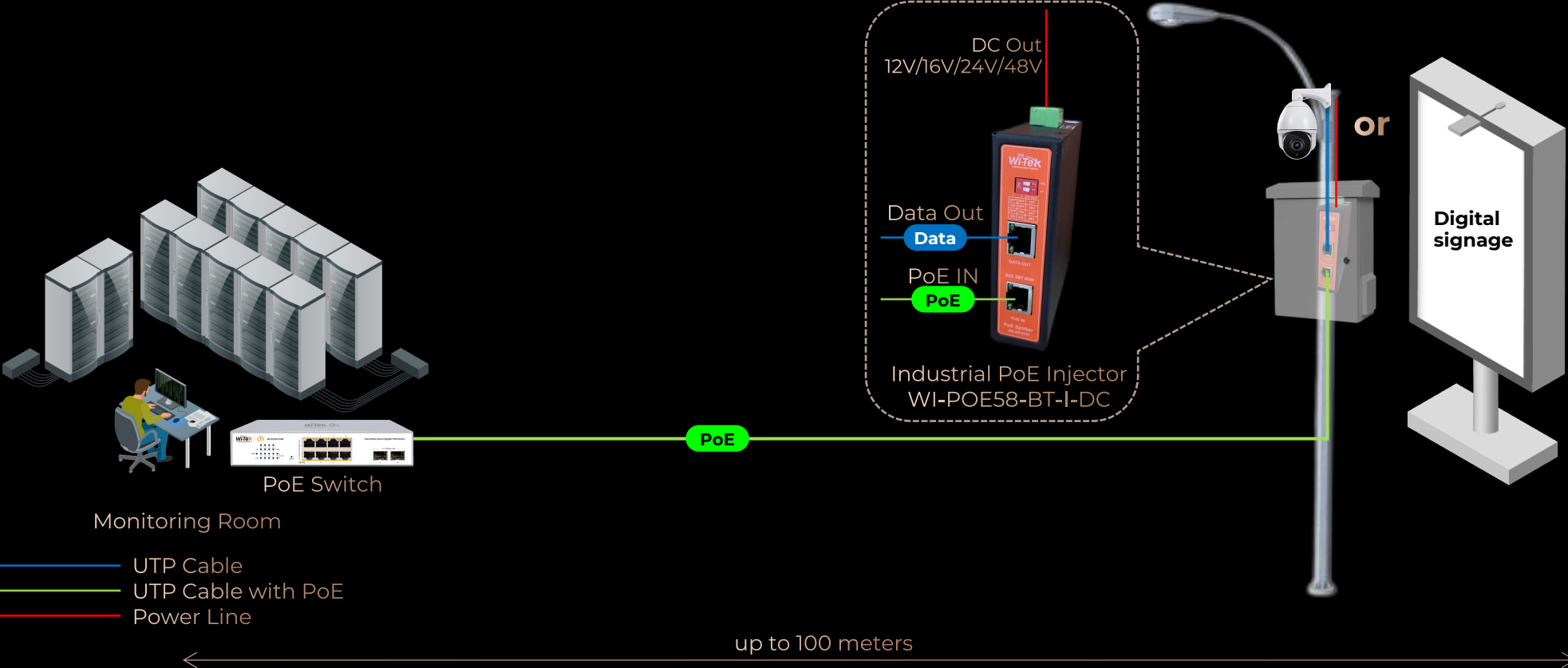

- UTP Cable
- UTP Cable with PoE
- Power Line

Accessory-PoE Extender Solution

650 Meters

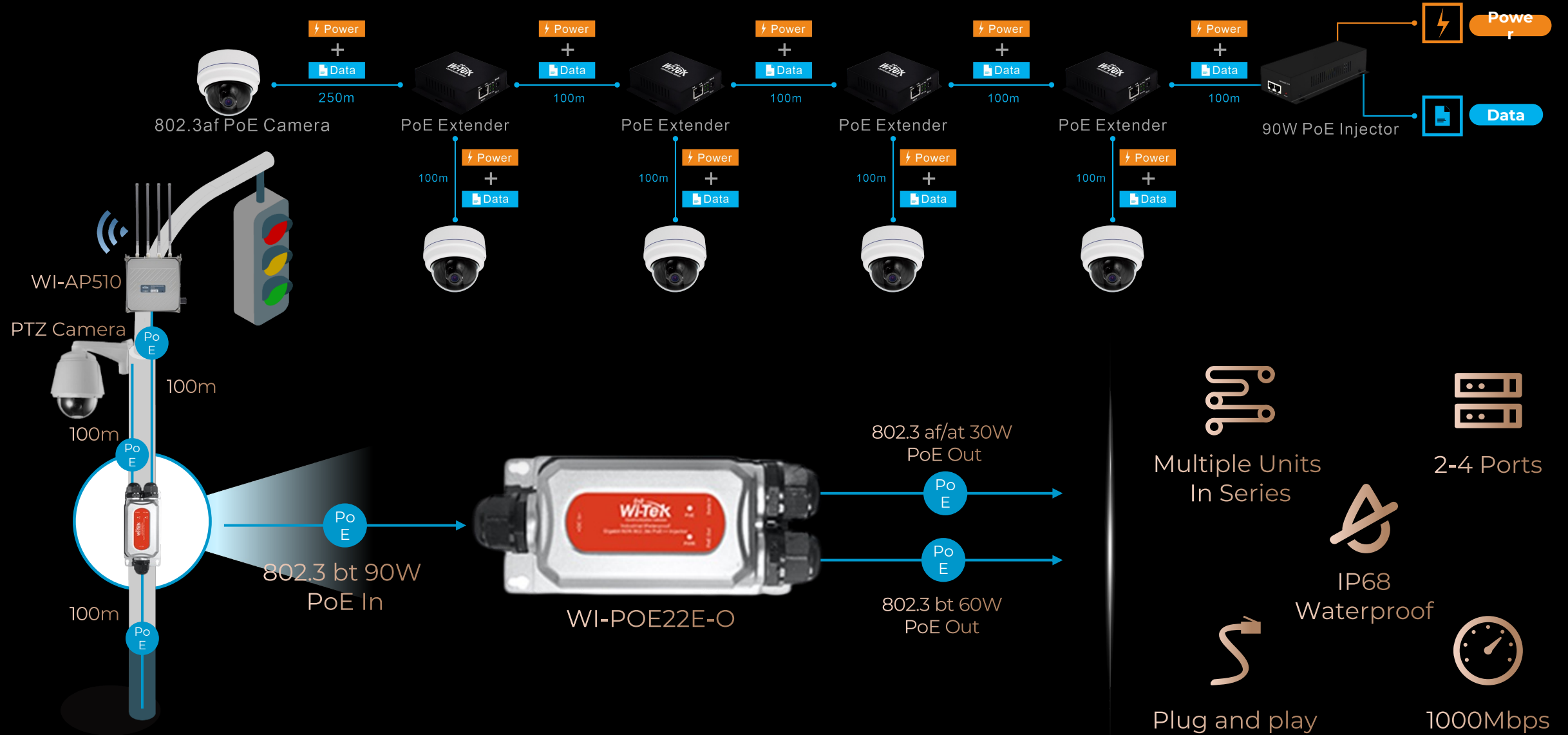



Communication Solution

Communication Solution



Cloud APP/ WEB



Official Website